

SF632(P)

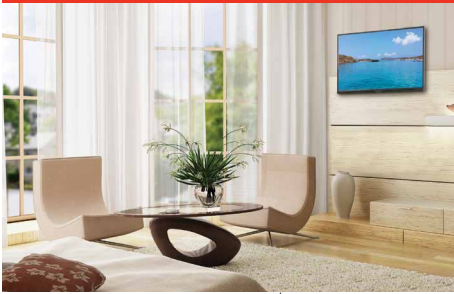

Mounting Pattern
75, 100, 200 x 100,
or 200 x 200mm



Max Load
115lb
(52kg)

SMARTMOUNT®

Flat Wall Mount

FOR 22" TO 40" DISPLAYS

The SmartMount® Flat Wall Mount series offers the most versatile installation features and mounting options. The SF632(P) models' low-profile design offers a sleek, aesthetically pleasing look to fit into any décor. Security screws provided in the SF632 model deter tampering and theft. The display can now simply be installed by a single person with the Hook-and-Hang™ system. The Easy-Glide™ adaptors hook onto the wall plate for an overall quick, simple and secure installation.

- Accommodates 75, 100, 200 x 100, or 200 x 200mm VESA® mounting patterns
- Slim design positions the display only 1.02" (26mm) from the wall
- Display adaptor simply slides into the wall plate for quick and easy installation
- Includes all necessary wall and display attachment hardware
- Integrated security options available
- Design is UL listed and tested to four times stated load capacity
- For mounts requiring theft resistant hardware, installed with security tool (included), please purchase SF632
- For mounts requiring standard hardware, installed with a Philips screwdriver, please purchase SF632P

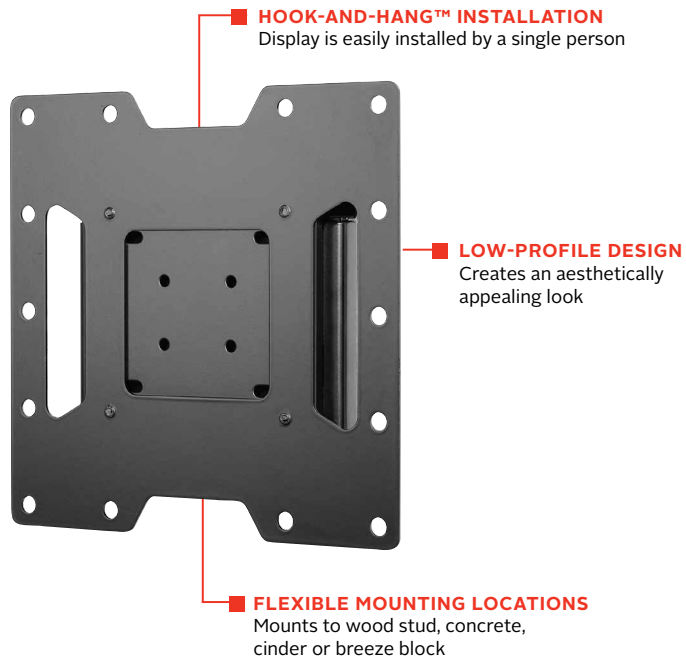

Low-profile design for a sleek, yet compact installation.



Comes in color packaging with included installation hardware and easy to follow instructions.



Please visit peerless-av.com/en-us/patents for patent information.

✉ info@peerless-av.com
🌐 peerless-av.com

peerless-AV®
Driving Technology Through Innovation

SF632P	SmartMount® Flat Wall Mount for 22" to 40" Displays - Standard Models
SF632	SmartMount® Flat Wall Mount for 22" to 40" Displays - Security Models

Product Specifications

	DIMENSIONS (W x H x D)	PRODUCT WEIGHT	LOAD CAPACITY	FINISH	AVAILABLE COLORS
SF632(P)	8.75" x 8.75" x 1.02" (222 x 222 x 26mm)	2.85lb (1.29kg)	115lb (52kg)	Scratch Resistant Fused Epoxy	Semi-Gloss Black

Package Specifications

	PACKAGE SIZE (W x H x D)	PACKAGE SHIP WEIGHT	PACKAGE UPC CODE	PACKAGE CONTENTS	UNITS IN PACKAGE
SF632(P)	11.38" x 3.60" x 10.50" (289 x 91 x 267mm)	3.8lb (1.7kg)	SF632: 735029241 621 SF632P: 735029241 645	Wall Mount, Wall and Display Installation Hardware, Installation Instructions	1

Accessories

- ACC215:** 2-pack Metal Stud Fastener Kit
- ACC4X4:** VESA® 400 x 400mm Adaptor Plate
- ACC-UCM:** Universal AV Component Mount

- ESHV models:** AV Wall Shelves
- IBA4-W:** Easy Mount Recessed Low Voltage Cable Plate
- IBA5-W:** Recessed Low Voltage Media Plate with Duplex Surge Suppressor

All dimensions = inch (mm)

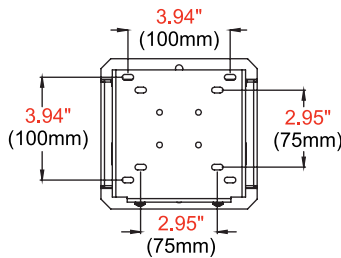

**FRONT VIEW
VESA 75/100**

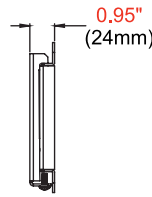

**SIDE VIEW
VESA 75/100**

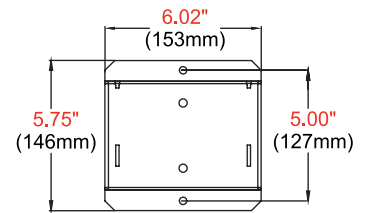

**WALL PLATE
DETAIL**

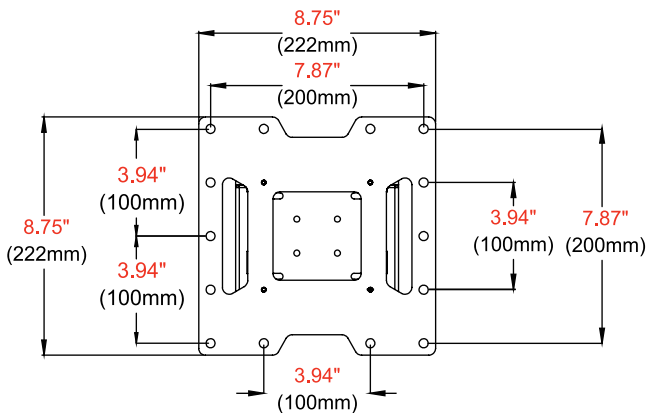

**FRONT VIEW
VESA 100/200**

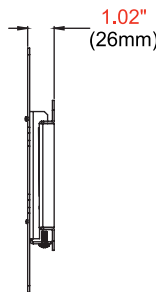

**SIDE VIEW
VESA 100/200**

Architect Specifications

The SmartMount® Flat Wall Mount shall be a Peerless-AV model SF632(P) and shall be located where indicated on the plans. Assembly and installation shall be done according to instructions provided by the manufacturer.

Visit peerless-av.com to see the complete line of AV solutions from Peerless-AV, including outdoor displays, wireless, kiosks, digital audio, display mounts, projector mounts, carts/stands, and a full assortment of accessories.

Peerless-AV
2300 White Oak Circle
Aurora, IL 60502 USA
(800) 865-2112
(630) 375-5100
Fax: (800) 359-6500

Peerless-AV EMEA
Unit 3 Watford Interchange
Colonial Way, Watford
Herts, WD24 4WP
United Kingdom
+44 (0) 1923 200100
Fax: +44 (0) 1923 200101

Peerless-AV Latin America
Ave de las Industrias 413
Parque Industrial Escobedo
Escobedo, N.L.,
Mexico 66062
+52 (81) 8384-8300
Fax: +52 (81) 8384-8360

